

Attn: \_\_\_\_\_

**Shorestation™ Aluminum Frame  
Specification Sheet**

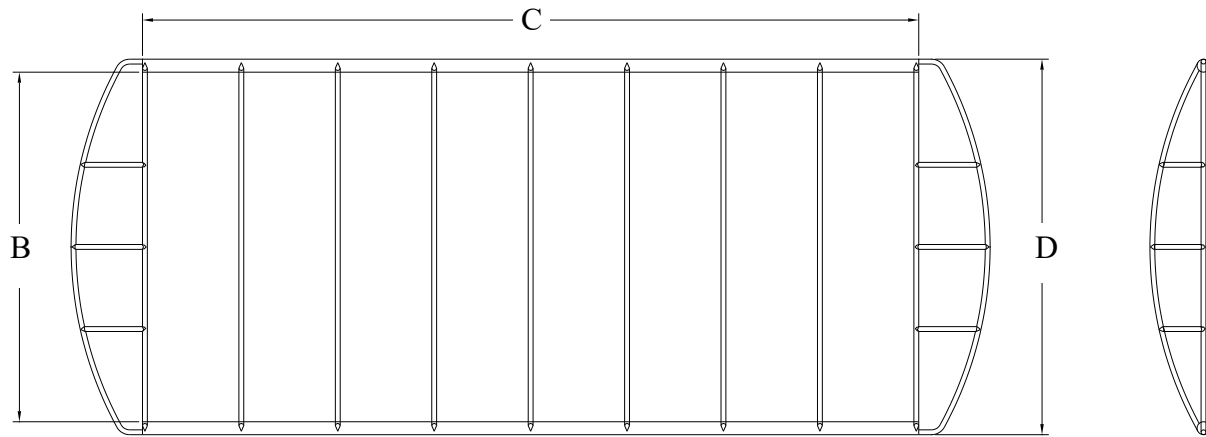

**\*ALL MEASUREMENTS (±1")**

PART NO.	SIZE	INSIDE WIDTH "B"	SIDE RAIL LENGTH "C"	OUTSIDE WIDTH "D"
SS1300062	13' X 62"	61 1/2"	11'	69 1/2"
SS2000088	20' X 88"	87 1/4"	18'	95 1/4"
SS1800100	18' X 100"	99 1/4"	16'	107 1/4"
SS2000100	20' X 100"	99 1/4"	18'	107 1/4"
SS2200100	22' X 100"	99 1/4"	20'	107 1/4"
SS1300108	13' X 108"	107 1/4"	11'	115 1/4"
SS2000108	20' X 108"	107 1/4"	18'	115 1/4"
SS2200108	22' X 108"	107 1/4"	20'	115 1/4"
SS2400108	24' X 108"	107 1/4"	22'	115 1/4"
SS2600108	26' X 108"	107 1/4"	24'	115 1/4"
SS2200120	22' x 120"	119 1/4"	20'	127 1/4"
SS2400120	24' X 120"	119 1/4"	22'	127 1/4"
SS2600120	26' X 120"	119 1/4"	24'	127 1/4"
SS2800120	28' X 120"	119 1/4"	26'	127 1/4"
SS3000120	30' X 120"	119 1/4"	28'	127 1/4"
SS2600132	26' X 132"	131 1/4"	24'	139 1/4"
SS3000132	30' X 132"	131 1/4"	28'	139 1/4"
SS3400132	34' X 132"	131 1/4"	32'	139 1/4"
SS3600144	36' X 144"	143 1/4"	34'	151 1/4"
SS4000144	40' X 144"	143 1/4"	38'	151 1/4"

\*Length is determined by adding 2' to Dimension 'C'.  
Dimension A is not used in the named size.

**ATTACHMENT**

Continuous bungee on each side and end connect by s-hook to holes punched in each bow  
OR

Continuous bungee loops over plastic pucks at each bow

STANDARD VALANCE: 20" VALANCE

**OUTSIDE DIMENSIONS**

- A \_\_\_\_\_ OVERALL LENGTH OF FRAME
- B \_\_\_\_\_ INSIDE WIDTH OF FRAME
- C \_\_\_\_\_ LENGTH OF SIDE RAILS (W/O ENDS)
- D \_\_\_\_\_ OUTSIDE WIDTH OF FRAME

**CONTACT INFORMATION**

Name \_\_\_\_\_  
Address \_\_\_\_\_  
City \_\_\_\_\_ State \_\_\_\_\_ Zip \_\_\_\_\_  
Phone \_\_\_\_\_ Fax \_\_\_\_\_  
Boat Lift Brand \_\_\_\_\_

**NOTES**

\_\_\_\_\_  
\_\_\_\_\_  
\_\_\_\_\_  
\_\_\_\_\_